

## Installation

### 1 Placement / Power

Avoid placing the Back-UPS in:

- Direct sunlight
- Excessive heat
- Excessive humidity or in contact with fluids of any type

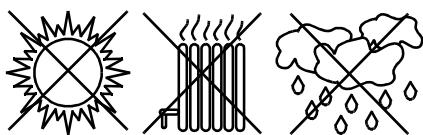

Plug the Back-UPS into a wall outlet, as shown.

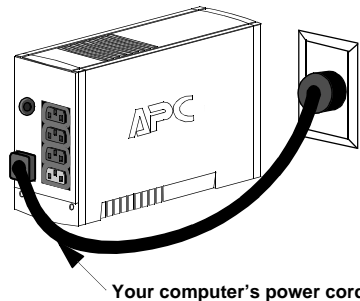

- The Back-UPS charges the internal battery any time it is connected to a wall outlet.

### 2 Connect Equipment to the Back-UPS

The rear panel of the Back-UPS consists of the following elements:

**Battery Back Up Outlets (qty. of 3).** These outlets provide battery back-up, surge protection, and Electro-magnetic Interference (EMI) filtering. In case of power outage, battery power is automatically provided to these outlets. Power (utility or battery) is not supplied to these outlets when the Back-UPS is switched **Off**. Connect a computer, monitor, and external disk or CD-ROM drive to these outlets.

**Surge Only Outlet.** This outlet is always **On** (when utility power is available) and is not controlled by the **On/Off** switch. This outlet does not provide power during a power outage. Connect a printer, fax machine or scanner to this outlet.

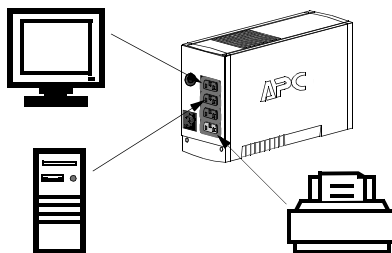

### 3 Switch on the Back-UPS

**Note:** Allow the Back-UPS to charge for a full eight hours prior to use.

Press the push-button on Back-UPS front panel.

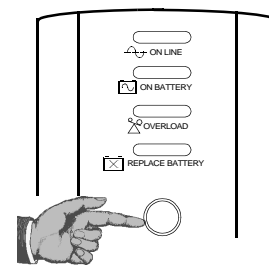

Observe that the following events occur after pressing and releasing the push-button:

- The green **On-Line** indicator flashes.
- The yellow **On Battery** indicator lights while the **Self-Test** is being performed.
- When **Self-Test** has successfully completed, only the green **On Line** indicator will be lit.
- If the internal battery is not connected, (see Step 1 above) the green **On Line** indicator and red **Replace Battery** indicator will light. The Back-UPS will also emit a chirping sound.

## Status Indicators and Alarms

There are four status indicators (lights) on the front panel of the Back-UPS (On Line, On Battery, Overload, and Replace Battery).

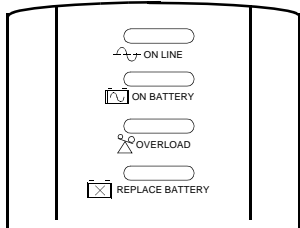

**On Line (green)** - is lit whenever utility power is powering the Battery Backup outlets.

**On Battery (yellow)** - is lit whenever the battery of the Back-UPS is powering equipment connected to the Battery Backup Outlets.

**Four Beeps Every 30 Seconds** - this alarm is sounded whenever the Back-UPS is running On Battery. Consider saving work in progress.

**Continuous Beeping** - this alarm is sounded whenever a low battery condition is reached. Battery run-time is very low. Promptly save any work in progress and exit all open applications. Shutdown the operating system, computer and the Back-UPS.

**Overload (red)** - is lit whenever power demand has exceeded the capacity of the Back-UPS.

**Continuous Tone** - this alarm is sounded whenever the Battery Backup outlets are overloaded.

**Circuit Breaker** - the circuit breaker button located on the rear panel of the Back-UPS will stick out if an overload condition forces the Back-UPS to disconnect itself from utility power. If the button sticks out, disconnect non-essential equipment. Reset the circuit breaker by pushing the button inward.

**Replace Battery (red)** - is lit whenever the battery is near the end of its useful life, or if the battery is not connected (see above). A battery that is near the end of its useful life has insufficient run-time and should be replaced.

**Chirps for 1 Minute Every 5 Hours** - this alarm is sounded whenever the battery has failed the automatic diagnostic test.

## Replace the Internal Battery

To replace the internal battery, proceed as follows:

**Note:** Replacing the battery is a safe procedure. However, small sparks may occur during the process. This is normal.

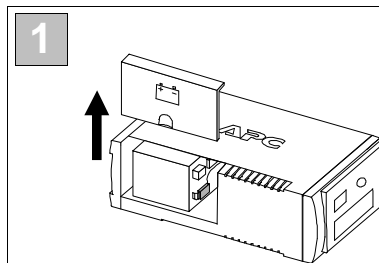

Place the unit on its side. Slide the battery compartment cover upward and off of the UPS.

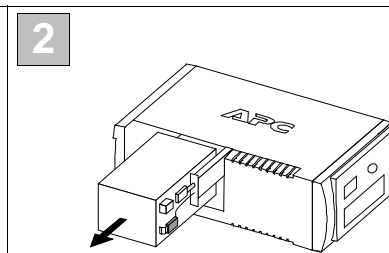

Pull the battery out, exposing the battery terminals and wires. Disconnect the wires from the terminals.

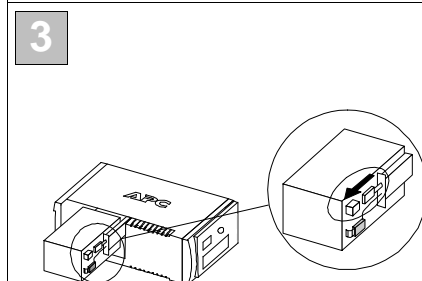

Slide the new battery into the battery compartment. Connect the battery wires to the terminals as follows:  
Black wire to Ground (-) terminal  
Red wire to Positive (+) terminal

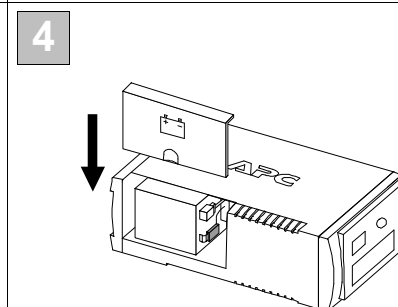

Align the battery compartment cover with the grooves in the UPS. Slide the cover down until it locks.

## Transfer Voltage Adjustment (optional)

In situations where the Back-UPS or connected equipment appears too sensitive to input voltage, it may be necessary to adjust the transfer voltage. This is a simple task requiring use of the front panel pushbutton. To adjust the transfer voltage, proceed as follows:

1. Plug the Back-UPS into the utility power source. The Back-UPS will be in a Standby Mode (no indicators lit).
2. Press the front panel pushbutton fully inward for 10 seconds. All indicators on the Back-UPS will flash to acknowledge going into Programming Mode.
3. The Back-UPS will then indicate its current Lower Transfer Voltage, as shown in the following table.

| Indicators Lit | Lower Transfer Voltage    | Use When  |
|----------------|---------------------------|---|
| 1              | 160 VAC                   | Back-UPS frequently goes On Battery due to low input voltage. |
| 2              | 180 VAC (factory default) | Normal power conditions exist.                                |
| 3              | 196 VAC                   | Connected equipment is sensitive to low voltage.              |

4. To select 160 volts as the Lower Transfer Voltage, press the pushbutton until 1 indicator is flashing.
5. To select 180 volts as the Lower Transfer Voltage, press the pushbutton until 2 indicators are flashing.
6. To select 196 volts as the Lower Transfer Voltage, press the pushbutton until 3 indicators are flashing.
7. Once in Programming Mode, if the pushbutton is not pressed within 5 seconds, the Back-UPS will exit the Programming Mode, and all indicators will extinguish.

## Order Replacement Battery

The typical battery lifetime is 3-6 years (depending on the number of discharge cycles and operating temperature). A replacement battery can be ordered over the phone from APC, or the battery can be ordered on-line from the APC web site (see below, a valid credit card is required).

When ordering, please specify Battery Cartridge **RBC2**.

## Back-UPS Storage

Before storing, charge the Back-UPS for at least eight hours. Store the Back-UPS covered and upright in a cool, dry location. During storage, recharge the battery in accordance with the following table:

| Storage Temperature        | Recharge Frequency | Charging Duration |
|----------------------------|--------------------|-------------------|
| -5° to 30°C (23° to 86°F)  | Every 6 months     | 8 hours           |
| 30° to 45°C (86° to 113°F) | Every 3 months     | 8 hours           |

Please contact APC Technical Support to troubleshoot the unit before returning it to APC.

## Troubleshooting

Use the tables below to solve minor Back-UPS installation and operation problems. Consult APC On-line Technical Support or call APC Technical Support for assistance with problems that cannot be resolved using this document:

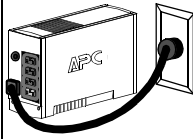
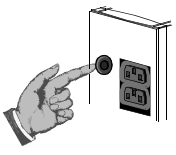
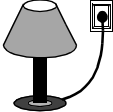
| Possible Cause                                | Procedure   |   |
|---|---|---|
| <b>Back-UPS will not switch on</b>            |   |   |
| Back-UPS not connected to an AC power source. | Check that the Back-UPS power plug is securely connected to the wall outlet.  |  |
| Back-UPS circuit breaker "tripped".           | Disconnect non-essential equipment from the Back-UPS. Reset the circuit breaker (located on the rear panel of the Back-UPS) by pushing the circuit breaker button fully inward until it catches. If the circuit breaker resets, switch the Back-UPS on and reconnect the equipment one-at-a-time. If the circuit breaker trips again, it is likely that one of the connected devices is causing the overload. |  |
| Very low or no utility voltage.               | Check the wall outlet that supplies power to the Back-UPS using a table lamp. If the lamp bulb is very dim, have the utility voltage checked by a qualified electrician.  |  |

### Back-UPS does not power computer/monitor/external drive during an outage

|  |  |
|--|--|
| Internal battery is not connected.   | Check the battery connections. (See "Connect the Battery" under "Installation" on the front page of this document. |
| Computer, monitor or external disk/CD-ROM drive is plugged into a Surge Only outlet. | Move computer, monitor, or external drive power cord plug to the Battery Backup outlets.                           |

### Back-UPS operates on battery although normal utility voltage exists

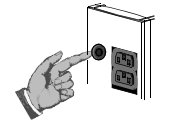
|  |  |  |
|--|--|--|
| Back-UPS circuit breaker "tripped".  | Disconnect non-essential equipment from the Back-UPS. Reset the circuit breaker (located on the rear panel of the Back-UPS) by pushing the circuit breaker button fully inward until it catches. |  |
| The wall outlet that the Back-UPS is connected to does not supply utility power to the unit. | Connect the Back-UPS to another wall outlet or have a qualified electrician check the building wiring.   |  |

### Back-UPS does not provide expected backup time

|   |  |
|---|--|
| Back-UPS is excessively loaded.   | Unplug non-essential Battery Backup connected equipment, such as printers and plug them into Surge Only outlets. Note: Devices that have motors or dimmer switches (laser printers, heaters, fans, lamps, and vacuum cleaners, for example) should not be connected to the Battery Backup outlets. |
| Back-UPS battery is weak due to recent outage and has not had time to recharge. | Charge the battery. The battery charges whenever the Back-UPS is connected to a wall outlet. Typically, eight hours of charging time are needed to fully charge the battery from total discharge. Back-UPS run-time is reduced until the battery is fully charged.                                 |
| Battery requires replacement.   | Replace battery (see Order Replacement Battery). Batteries typically last 3-6 years, shorter if subjected to frequent power outages or elevated temperatures.  |

### A red indicator is lit

|   |   |
|---|---|
| Battery is not connected properly.  | Check the battery connections. Consult "Connect the Battery" under "Installation" on the front page of this document. It shows how to access the battery and connect the wires. |
| The Overload indicator is lit if equipment connected to the Battery Backup outlets is drawing more power than the Back-UPS can provide. | Move one or more equipment power plugs to the Surge Only outlets.   |
| Battery requires replacement.   | The battery should be replaced within two weeks (see "Order Replacement Battery"). Failure to replace the battery will result in reduced run-time during a power outage.        |

### Red indicators are flashing

|                   |                       |
|-------------------|-----------------------|
| Back-UPS failure. | Call APC for service. |
|-------------------|-----------------------|

### Replace Battery indicator lit and an alarm sounds when the Back-UPS is turned on

|                                 |                                |
|---------------------------------|--------------------------------|
| Internal battery not connected. | Check the battery connections. |
|---------------------------------|--------------------------------|

## Specifications

|   |  |
|---|--|
| Input Voltage (on line)                 | 180 - 264 Vac (default setting)  |
| Frequency Limits (on line)              | 47 - 63 Hz (autosensing)   |
| On Battery Waveshape                    | Stepped Sine Wave  |
| Maximum Load                            | 325 VA - 195 W    475 VA - 285 W   |
| Typical Recharge Time                   | 8 Hours  |
| Operating Temperature                   | 0° to 40°C (32° to 104°F)  |
| Storage Temperature                     | -5° to 45°C (23° to 113°F)   |
| Operating and Storage Relative Humidity | 0 to 95% non-condensing  |
| Size (H x W x D)                        | 16.5 x 9.2 x 28.5 cm    (6.5 x 3.6 x 11.2 inches)  |
| Weight                                  | 325 VA - 5.72 kg (12.6 lb)    475 VA - 5.72 kg (12.6 lb)   |
| Shipping Weight                         | 325 VA - 6.72 kg (14.8 lb)    475 VA - 6.72 kg (14.8 lb)   |
| EMI Classification                      | EN 55022, IEC 801-2 and 801-4 (level IV), and IEC 801-3 (level III)  |
| On Battery Run-Time                     | 325 VA - 14 Minutes typical - desktop computer and 38.1 cm (15 inch) monitor.<br>475 VA - 18 Minutes typical - desktop computer and 38.1 cm (15 inch) monitor. |

## Service

**Note:** If the UPS requires service, do not return it to the dealer. The following steps should be taken:

- Consult the Troubleshooting section to eliminate common problems.
- Determine if the circuit breaker is tripped. If the circuit breaker is tripped, reset the breaker and determine if the problem still exists.
- If the problem persists, consult the APC Worldwide Web site ([www.apcc.com](http://www.apcc.com)) or call customer service.
  - Record the model number of the UPS, the serial number, and the date purchased. Be prepared to troubleshoot the problem over the telephone with a technician. If this is not successful, the technician will issue a Return Merchandise Authorization Number (RMA#) and a shipping address.
  - If the UPS is under warranty, repairs are free. If not, there is a repair charge.
- Pack the UPS in its original packaging. If the original packing is not available, ask customer service about obtaining a new set. Pack the UPS properly to avoid damage in transit.

**Note:** Never use Styrofoam™ beads for packaging. Damage sustained in transit is not covered under warranty (insuring the package for full value is recommended).

- Write the RMA# on the outside of the package.
- Return the UPS by insured, prepaid carrier to the address provided by customer service.

## Warranty

The standard warranty is two (2) years from the date of purchase. APC's standard procedure is to replace the original unit with a factory reconditioned unit. Customers who must have the original unit back due to assigned asset tags and set depreciation schedules must declare such a need at first contact with an APC Technical Support representative. APC will ship the replacement unit once the defective unit has been received by the repair department, or cross ship upon the receipt of a valid credit card number. The customer pays for shipping the unit to APC. APC pays ground freight transportation costs to ship the replacement to the customer.

## APC Contact Information

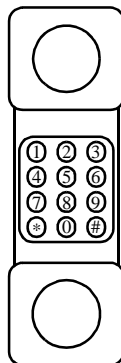

|                          |  |
|--------------------------|--|
| <b>Worldwide</b>         | <b>1.401.789.5735</b>  |
| <b>APC Asia Pacific</b>  | <b>+612-9955-9366</b>  |
| <b>APC Europe</b>        | <b>+353-91-702000</b>  |
| <b>APC Latin America</b> | <b>+305-266-5005</b>   |
| <b>APC North America</b> | <b>1.800.800.4272</b>  |
| <b>Internet</b>          | <b><a href="http://www.apc.com">http://www.apc.com</a></b>                 |
| <b>Technical Support</b> | <b><a href="http://www.apc.com/support">http://www.apc.com/support</a></b> |